

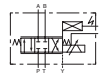
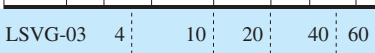
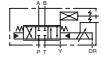
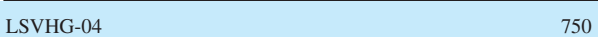
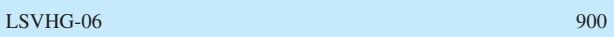
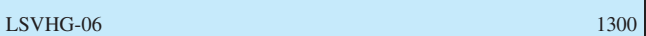
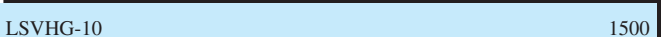

SERVO VALVES

Valve Type	Graphic Symbols	Maximum Operating Pressure MPa (PSI)	Maximum Flow		Page
			L/min	U.S.GPM	
Direct Type High Speed Linear Servo Valves		35 (5080)			798
Two Stage Type High Speed Linear Servo Valves		35 (5080)			800
		35 (5080)			
		31.5 (4570)			
		31.5 (4570)			
Linear Servo Amplifier	—	—	—		802
OBE Type Linear Servo Valves		31.5 (4570)			803
		35 (5080)			
		35 (5080)			
		31.5 (4570)			

Consult Yuken when detailed material such as dimensions figures is required.

High Speed Linear Servo Valves

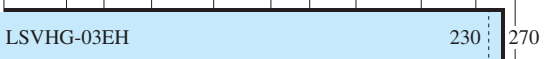
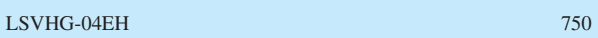
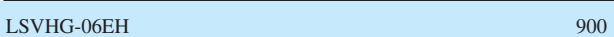
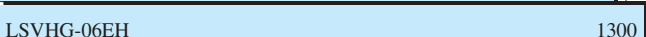
High-speed linear servo valves have outstanding features of high response and exceptional contamination resistance. These features are achieved by the compact and powerful linear motor which directly drives the spool and gives electric feedback of the spool position. These valves have garnered an excellent reputation since their launch by Yuken in 2001. Direct type LSVG-03 and two stage type LSVHG-04/06/10(which use the LSVG-03 as a pilot) are available.

Direct Type High Speed Linear Servo Valves

- **High accuracy**

These valves have a low hysteresis of 0.1 % or less, achieving high accuracy. They allow the main unit to operate with much higher repeatability.

- **High response characteristics**

The valves provide significantly high levels of step and frequency responses, which are typically used as measures of response characteristics; the step response is 2 ms (0 ⇔ 100 %)*, and the frequency response is 450 Hz/- 90° (± 25 % amplitude)*. Thus, the valves ensure that the main unit can achieve unprecedented high response.

(*: Representative values)

- **Excellent vibration-proof characteristics**

With a simple structure, the valves offer high vibration resistance.

- **Excellent contamination resistance**

The valves are also featured by excellent contamination resistance since they have a simple structure that directly connects the linear motor moving coil, the spool, and the position sensor. Compared to conventional servo valves for which the permissible contamination level is up to NAS 1638 class 7, the direct type linear servo valves can accept the contamination level of up to NAS 1638 class 10. These valves can contribute to greatly reducing the cost of fluid management.

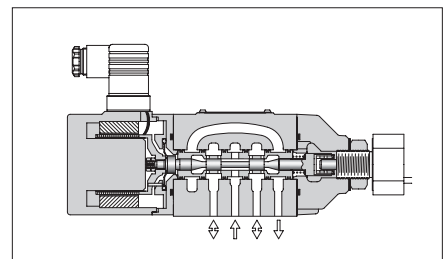

Graphic Symbol

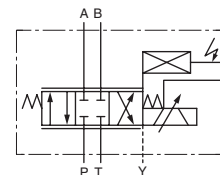

Model Number Deignation

F-	LSVG	-03	-40	-R	-10
Special Seals	Series Number	Valve Size	Rated Flow @ΔP = 7 MPa (@ΔP = 1020 PSI)	Cable Departure Direction	Design Number
F Special Seals for Phosphate Ester Type Fluid (Omit if not required).	LSVG: Direct Type High Speed Linear Servo Valves	03	4 = 4 L/mi n (1.06 U. S. GPM) 10 =10 L/mi n (2.64 U. S. GPM) 20 =20 L/mi n (5.28 U. S. GPM) 40 =40 L/mi n (10.57 U. S. GPM) 60 =60 L/mi n (15.85 U. S. GPM)	(Viewed from the linear motor side) None: Upper (Standard) R: Right L: Left	10

Specifications

The specifications below are for use with a 48 VDC type exclusive amplifier; for use with a 24 VDC type amplifier, see the values in parentheses { }.

Model Numbers		LSVG-03-4/10/20/40	LSVG-03-60
Description			
Rated Flow @ $\Delta P = 7 \text{ MPa}$ (1020 PSI) ⁽¹⁾		4, 10, 20, 40 L/min (1.06, 2.64, 5.28, 10.57 U. S. GPM)	60 L/min (15.85 U. S. GPM)
Max. Operating Pressure		35 MPa (5080 PSI)	
Proof Pres. at Return Port		35 MPa (5080 PSI)	
Drain Port (Y) Permissible Back Pres. ⁽²⁾		0.05 MPa (7 PSI)	
Null Leakage @ $P_s = 14 \text{ MPa}$ (2030 PSI) 32 mm ² /s (150 SSU)		1.7 L/min (.45 U.S. GPM) or less	
Hysteresis		0.1 % or less	
Step Response (0 \leftrightarrow 100 %, Typical) ⁽³⁾		2 ms {3 ms}	3 ms {4 ms}
Frequency Response (± 25 % Amplitude, Typical) ⁽³⁾	Gain: - 3 dB	350 Hz {300 Hz}	330 Hz {240 Hz}
	Phase: - 90°	450 Hz {370 Hz}	410 Hz {330 Hz}
Vibration Proof ⁽⁴⁾		Frequency: 10 - 60 Hz, Amplitude: 4 mm (.157 in.), Acceleration: 7.8 - 282 m/s ² (25.6 to 925 ft./s ²) Frequency: 61 - 2000 Hz, Amplitude: 4 - 0.0038 mm (.157 - .00015 in.), Acceleration: 294 m/s ² (965 ft./s ²)	
Protection		IP 64	
Ambient Temperature		- 15 to + 60 °C (5 to 140°F)	
Spool Type		Neutral / Zero Lap	
Spool Stroke to Stops		$\pm 0.5 \text{ mm}$ ($\pm .0197 \text{ inches}$)	$\pm 7.5 \text{ mm}$ ($\pm .0295 \text{ inches}$)
Linear Motor Specification	Current	2 A [Max. 6 A]	
	Coil Resistance	4.5 Ω [at 20 °C (68 °F)]	
Mass		5 kg (11.0 lbs.)	
Applicable Servo Amplifier		AMLS-A-D*-*-10	AMLS-B-D*-*-10

Note: (1) Use the valves so that the relationship between the valve pressure difference and the flow rate, as specified below in "Range of Flow Control" is met.

(2) Back pressure at the drain port (Y) should be 0.05 MPa (7 PSI) or less and not be a negative pressure.

(3) This value is measured for each valve; it may differ depending on the actual circuit.

(4) There are restrictions on the mounting position; consult Yuken for details.

Range of Flow Control

Control Method: 4-Way Valve

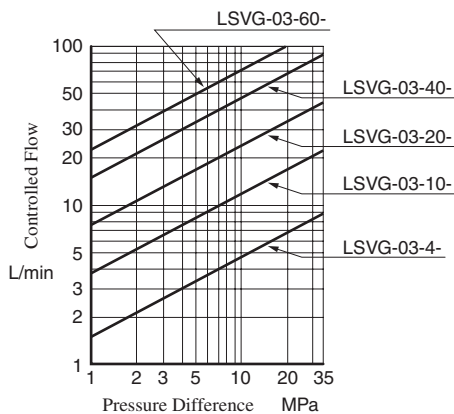
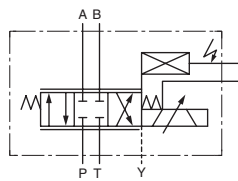

Control Method: 3-Way Valve

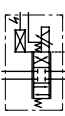
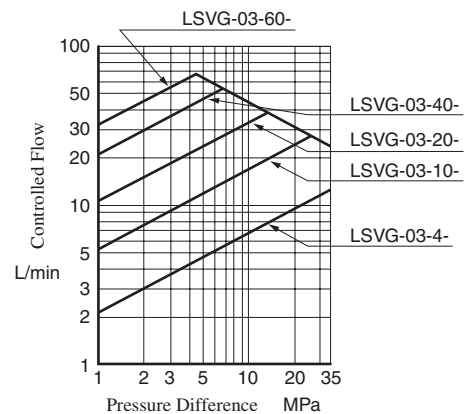
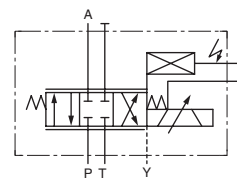

Two Stage Type High Speed Linear Servo Valves

Two stage type linear servo valves are a type of high-flow servo valve that has a direct type high-speed linear servo valve in its pilot stage to drive the main spool.

These valves control the positions of the pilot and main spools with electrical feedback, achieving high accuracy and response.

● **High flow**

The valves consist of two stages to provide a high flow rate [Rated flow at $\Delta P = 7 \text{ MPa}$ (1020 PSI): 750 to 1500 L/min (198 to 396 U.S.GPM)].

● **High accuracy**

The valves have a low hysteresis of 0.1 % or less, achieving high accuracy. They allow the main unit to operate with much higher repeatability.

● **High response characteristics**

The valves provide significantly high levels of step and frequency responses, which are typically used as measures of response characteristics; the step response is 8 ms ($0 \leftrightarrow 100\%$), and the frequency response is 100 Hz/- 90° ($\pm 25\%$ amplitude) (Representative values for LSVHG-10-1500). Thus, the valves ensure the achievement of unprecedented high response.

● **Excellent contamination resistance**

As is the case with the direct type linear servo valves, the permissible level of fluid contamination for these valves is up to NAS 1638 class 10.

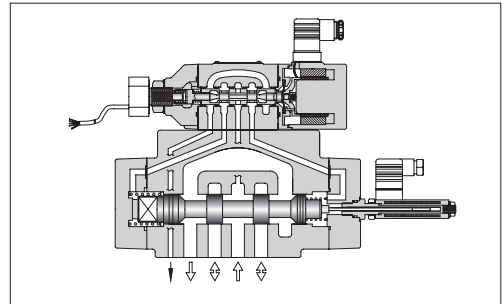
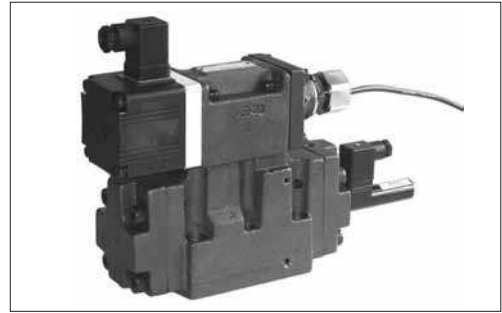

Graphic Symbols

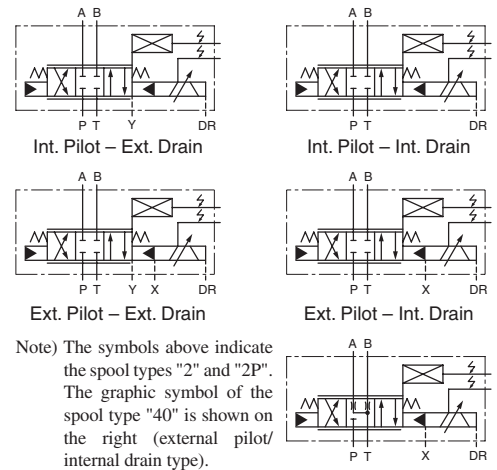

■ **Model Number Deignation**

F-	LSVHG	-06	-900	-2P	-E	T	-R	-10
Special Seals	Series Number	Valve Size	Rated Flow @ $\Delta P = 7 \text{ MPa}$ (@ $\Delta P = 1020 \text{ PSI}$)	Spool Type	Pilot Connection	Drain Connection	Cable Departure Direction	Design Number
F: Special Seals for Phosphate Ester Type Fluid (Omit if not required).	LSVHG: Two Stage Type High Speed Linear Servo Valves	04	750: 750 L/min (198 U. S. GPM)	2: 10 % Overlap 	None: Internal Pilot E: External Pilot	None: External Pilot T: Internal Pilot	(Viewed from the linear motor side) None: Upper (Standard) R: Right L: Left	10
		06	900: 900 L/min (238 U. S. GPM) 1300: 1300 L/min (343 U. S. GPM)	40: Open Centre A, B & T 				10
		10	1500: 1500 L/min (396 U. S. GPM)	2P: Zero Lap (Dual Flow Gain)				10

Specifications

The specifications below are for use with a DC 48 V type exclusive amplifier; for use with a DC 24 V type amplifier, see the values in parentheses { }.

Model Numbers		LSVHG-04-750	LSVHG-06-900	LSVHG-06-1300	LSVHG-10-1500		
Description							
Rated Flow	$\Delta P = 7 \text{ MPa (1020 PSI)}$ (4-Way Valve)	750 L/min {198 U. S. GPM}	900 L/min {238 U. S. GPM}	1300 L/min {343 U. S. GPM}	1500 L/min {396 U. S. GPM}		
	$\Delta P = 0.5 \text{ MPa (73 PSI)}$ (Per Land)	283 L/min {74.8 U. S. GPM}	340 L/min {89.8 U. S. GPM}	490 L/min {129 U. S. GPM}	600 L/min {159 U. S. GPM}		
Max. Operating Pressure		35 MPa (5080 PSI)	35 MPa (5080 PSI)	31.5 MPa (4570 PSI)	31.5 MPa (4570 PSI)		
Proof Pres. at Return Port	External Drain	31.5 MPa (4570 PSI)	35 MPa (5080 PSI)	25 MPa (3630 PSI)	21 MPa (3050 PSI)		
	Internal Drain ⁽¹⁾						
Drain Port (DR Port) Permissible Back Pressure ⁽²⁾		0.05 MPa (7 PSI)					
Pilot Pressure ⁽³⁾		1.5 - 35 MPa (220 - 5080 PSI)			1.5 - 25 MPa (220 - 3630 PSI)		
Pilot Flow Rate ⁽⁴⁾ L/min (U. S. GPM)		27 (7.1) or more {22 (5.8)} or more	30 (7.9) or more {24 (6.3)} or more	34 (9.0) or more {27 (7.1)} or more	30 (7.9) or more {30 (7.9)} or more		
Max. Leakage $P_s = P_p = 14 \text{ MPa}$ (2030 PSI) @ Viscosity: 32 mm ² /s (150 SSU)	Pilot Valve		1.7 L/min (.45 U.S. GPM)				
	Main Valve	Spool Type	- 2 -	0.8 L/min (.21 U. S. GPM)	0.9 L/min (.24 U. S. GPM)	1 L/min (.26 U. S. GPM)	3 L/min (.79 U. S. GPM)
			- 40 -	1.6 L/min (.42 U. S. GPM)	1.8 L/min (.48 U. S. GPM)	2 L/min (.53 U. S. GPM)	6 L/min (1.59 U. S. GPM)
			- 2P -	6.8 L/min (1.80 U. S. GPM)	7 L/min (1.85 U. S. GPM)	8 L/min (2.11 U. S. GPM)	10 L/min (2.64 U. S. GPM)
Hysteresis		0.1 % or less					
Step Response (0 \leftrightarrow 100 %, Typical) ⁽⁵⁾		8 ms {10 ms}	8 ms {10 ms}	10 ms {13 ms}	8 ms {8 ms}		
Frequency Response (± 25 % Amplitude, Typical) ⁽⁵⁾	Gain: - 3 dB	150 Hz {140 Hz}	160 Hz {130 Hz}	150 Hz {110 Hz}	160 Hz {150 Hz}		
	Phase: - 90°	110 Hz {100 Hz}	105 Hz {100 Hz}	100 Hz {100 Hz}	100 Hz {100 Hz}		
Vibration Proof ⁽⁶⁾		Frequency: 10 - 60 Hz, Amplitude: 4 mm (.157 in.), Acceleration: 7.8 - 282 m/s ² (25.6 to 925 ft./s ²) Frequency: 61 - 2000 Hz, Amplitude: 4 - 0.0038 mm (.157 - .00015 in.), Acceleration: 294 m/s ² (965 ft./s ²)					
Protection		IP 64					
Ambient Temperature		- 15 to + 60 °C (5 to 140°F)					
Spool Stroke to Stops		$\pm 5 \text{ mm}$ ($\pm .197 \text{ in.}$)	$\pm 5 \text{ mm}$ ($\pm .197 \text{ in.}$)	$\pm 7 \text{ mm}$ ($\pm .276 \text{ in.}$)	$\pm 5 \text{ mm}$ ($\pm .197 \text{ in.}$)		
Spool End Area		7.1 cm ² (.011 Sq. in.)	8 cm ² (.012 Sq. in.)	8 cm ² (.012 Sq. in.)	8 cm ² (.012 Sq. in.)		
Linear Motor Specification	Current	2 A [Max. 6 A]					
	Coil Resistance	4.5 Ω [at 20 °C (68 °F)]					
Mass		12 kg (26.5 lbs.)	20 kg (44.1 lbs.)	21 kg (46.3 lbs.)	54 kg (119 lbs.)		
Applicable Servo Amplifier		AMLS-C2-D*-*-10	AMLS-C-D*-*-10	AMLS-D-D*-*-10	AMLS-C-D*-*-10		

Note: (1) Pressure at the return port should be at actual supply pressure or less.

(2) Back pressure at the drain port should be 0.05 MPa (7 PSI) or less and not be a negative pressure.

(3) Supply pressure for the pilot valve should be 1.5 to 35 MPa (220 to 5080 PSI) {1.5 to 25 MPa (220 to 3630 PSI) for LSVHG-10} and should also be 60 % of actual supply pressure or more.

(4) The pilot flow is calculated based on 14 MPa (2030 PSI) of pilot pressure and the above step response.

(5) This value is measured for each valve based on 14 MPa (2030 PSI) of pilot pressure; it may differ depending on the actual circuit/operation conditions.

(6) There are restrictions on the mounting position; consult Yuken for details.

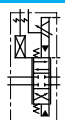

Linear Servo Amplifier

This amplifier is used to drive LSVG/LSVHG series high speed linear servo valves. With an optimal design for the servo valves, the amplifier can maximize the valve performance.



Specifications

Model Numbers	AMLS-*-D48-*-10	AMLS-*-D24-*-10
Description		
Power Supply	DC 48 V ± 2.4 V (200 VA or more)	DC 24 V ± 1.2 V (75 VA or more)
Rated Output Current	Continuous ± 2 A (4 A Peak)	Continuous ± 2 A (3 A Peak)
Input / Output Signal	Output Signal = Spool Travel Monitoring	
AMLS-*-D48/D24-A1-	Voltage Signal ± 10 V (R _i = 100 kΩ, R _L ≥ 10 kΩ)	
AMLS-*-D48/D24-B1-	Current Signal 4 - 20 mA (R _i = 200 Ω, R _L ≥ 100 - 500 kΩ)	
AMLS-*-D48/D24-C1-	Current Signal ± 10 mA (R _i = 200 Ω, R _L ≥ 100 - 500 kΩ)	
Control Input / Output Signal	a) Servo "ON" Input/Alarm Reset Input: Photocoupler Input Voltage: + 15 VDC to + 28 V, Input Impedance: 2.2 kΩ b) Overcurrent Output (Curr.AL.)/Deviation Alarm Output (CRTL.AL.): Photocoupler Output Voltage: Max. 50 VDC, Current: Max. 30 mA	
Ambient Temperature	0 - 50 °C (32 - 122°F)	
Ambient Humidity	20 - 90 %RH (No Condensation)	
Mass	1.8 kg (4.0 lbs.)	

Model Number Deignation

AMLS	-A	-D48	-A1	-10
Series Number	Applicable Valve Type	Supply Voltage	Input Signal/Spool Travel Monitoring	Design Number
AMLS: Linear Servo Amplifier	A: LSVG-03-4/10/20/40 B: LSVG-03-60 C: LSVHG-06-900 & LSVHG-10-1500 C2: LSVHG-04-750 D: LSVHG-06-1300	D48: 48 VDC D24: 24 VDC	A1: Voltage Signal ± 10 V B1: Current Signal 4 to 20 mA C1: Current Signal ± 10 mA	10

I/O Signal Characteristics

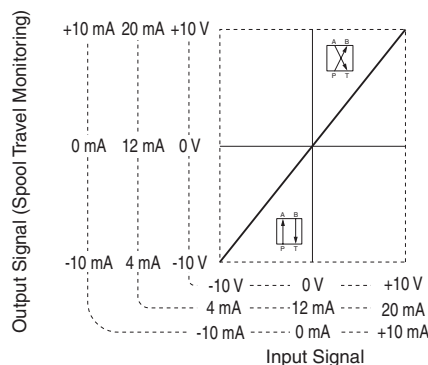

OBE (On-Board Electronics) Type Linear Servo Valves

On-board electronics type linear servo valves have been developed based on high-speed linear servo valves, but with a focus on downsizing the pilot valve. The integration of the exclusive amplifier and the linear servo valve create a high performance valve in a compact package which greatly improves user-friendliness.

● **High accurate, simple and convenient — Ideal on-board electronics type linear servo valves**

Convenient

Fault diagnosis is easy to conduct with the alarm indication when the command signal and the spool position differ due to abnormality in the system.

Colour	Description of Alarm Indicator
Green	Indication of power supply (Normal operation)
Red	Deviation alarm for the pilot vlve
Yellow	Deviation alarm for the main vlve

High Accuracy

Closed loop control by the combination of the position sensors for the polot valve and the main valve in the compact amplifiers ensures excellent linearity, hysteresis and stability on control.

Graphic Symbols

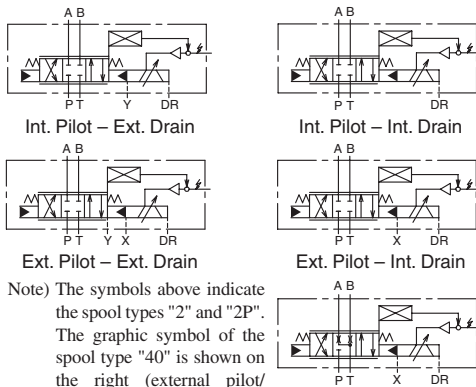

Simple

Highly accurate hydraulic control can be obtained only by supplying 24 V DC power and inputting a command signal.



■ **Model Number Deignation**

F-	LSVHG	-06	EH	-900	-2P	-E	T	-A	1	-20
Special Seals	Series Number	Valve Size	Amp. Type	Rated Flow @ΔP = 7 MPa (@ΔP = 1020 PSI)	Spool Type	Pilot Connection	Drain Connection	Input Signal/Spool Travel Monitoring	Connector Type	Design Number
F: Special Seals for Phosphate Ester Type Fluid (Omit if not required).	LSVHG: Two Stage Type Linear Servo Valves	03	EH: OBE Type	230: 230 L/min (60.8 U. S. GPM)	2L: 2 % Overlap (Linear Flow Gain)	None: Internal Pilot E: External Pilot	None: External Drain T: Internal Drain	A: Voltage Signal ± 10 V B: Current Signal 4 to 20 mA C: Current Signal ± 10 mA	1: 6 + PE Pole 2: 11 + PE Pole	20
				270: 270 L/min (71.3 U. S. GPM)	2: 10 % Overlap 					
		04		750: 750 L/min (198 U. S. GPM)	40: Open Centre A, B & T 					
		06		900: 900 L/min (238 U. S. GPM) 1300: 1300 L/min (343 U. S. GPM)	2P: Zero Lap (Dual Flow Gain)					

Specifications

Model Numbers		LSVHG-03EH -230-2L	LSVHG-03EH -270-*	LSVHG-04EH -750-*	LSVHG-06EH -900-*	LSVHG-06EH -1300-*		
Description								
Rated Flow	$\Delta P = 7 \text{ MPa (1020 PSI)}$ (4-Way Valve)	230 L/min {60.8 U. S. GPM}	270 L/min {71.3 U. S. GPM}	750 L/min {198 U. S. GPM}	900 L/min {238 U. S. GPM}	1300 L/min {343 U. S. GPM}		
	$\Delta P = 0.5 \text{ MPa (73 PSI)}$ (Per Land)	87 L/min {23 U. S. GPM}	102 L/min {26.9 U. S. GPM}	283 L/min {74.8 U. S. GPM}	340 L/min {89.8 U. S. GPM}	490 L/min {129 U. S. GPM}		
Max. Operating Pressure		31.5 MPa ⁽⁵⁾ (4570 PSI)		35 MPa (5080 PSI)	35 MPa (5080 PSI)	31.5 MPa (4570 PSI)		
Proof Pres. at Return Port ⁽¹⁾	External Drain	Port "T"	21 MPa ⁽⁵⁾ (3050 PSI)	31.5 MPa (4570 PSI)	35 MPa (5080 PSI)	25 MPa (3630 PSI)		
		Port "Y"	21 MPa ⁽⁵⁾ (3050 PSI)	21 MPa (3050 PSI)				
	Internal Drain	Port "T" & "Y"	21 MPa ⁽⁵⁾ (3050 PSI)	21 MPa (3050 PSI)				
Drain Port (DR Port) Permissible Back Pressure. ⁽²⁾		0.05 MPa (7 PSI)						
Pilot Pressure ⁽³⁾		1.5 - 21 MPa (220 - 3050 PSI)						
Pilot Flow Rate ⁽⁴⁾ L/min (U. S. GPM)		9 (2.4) or more		20 (5.3) or more	22 (5.8) or more	23 (6.1) or more		
Max. Leakage $P_s = P_p = 14 \text{ MPa}$ (2030 PSI) @ Viscosity: 32 mm ² /s (150 SSU)	Pilot Valve		0.8 L/min (.21 U.S. GPM)		1.2 L/min (.32 U.S. GPM)			
	Main Valve	Spool Type	- 2L -	1.6 L/min (.42 U. S. GPM)	—	—	—	
			- 2 -	—	0.5 L/min (.13 U. S. GPM)	0.8 L/min (.21 U. S. GPM)	0.9 L/min (.24 U. S. GPM)	1 L/min (.26 U. S. GPM)
			- 40 -	—	1 L/min (.26 U. S. GPM)	1.6 L/min (.42 U. S. GPM)	1.8 L/min (.48 U. S. GPM)	2 L/min (.53 U. S. GPM)
			- 2P -	—	5.6 L/min (1.48 U. S. GPM)	6.8 L/min (1.8 U. S. GPM)	7 L/min (1.85 U. S. GPM)	8 L/min (2.11 U. S. GPM)
Hysteresis		0.1 % or less						
Step Response (0↔100 %, Typical) ⁽⁶⁾		8 ms	7 ms	11 ms	11 ms	15 ms		
Frequency Response (± 25 % Amplitude, Typical) ⁽⁶⁾	Gain: - 3 dB	120 Hz	125 Hz	100 Hz	100 Hz	75 Hz		
	Phase: - 90°	110 Hz	110 Hz	90 Hz	90 Hz	70 Hz		
Vibration Proof ⁽⁷⁾		100 m/s ²						
Protection		IP 65						
Ambient Temperature		0 to + 50 °C (32 to 122 °F)						
Spool Stroke to Stops		± 4 mm (± .157 in.)	± 3.5 mm (± .138 in.)	± 5 mm (± .197 in.)	± 5 mm (± .197 in.)	± 7 mm (± .276 in.)		
Spool End Area		3 cm ² (.0047 Sq. in.)		7 cm ² (.010 Sq. in.)	8 cm ² (.012 Sq. in.)	8 cm ² (.012 Sq. in.)		
Linear Motor Specification	Current	Max. 2.1 A						
	Coil Resistance	9.6 Ω [at 20 °C (68 °F)]						
Mass		8.5 kg (18.7 lbs.)		14 kg (30.9 lbs.)	20 kg (44.1 lbs.)	20 kg (44.1 lbs.)		
Electric Connection		6 + PE / 11 + PE Connector						

Note: (1) Pressure at the return port should be at actual supply pressure or less.

(2) Back pressure at the drain port should be 0.05 MPa (7 PSI) or less and not be a negative pressure.

(3) Supply pressure for the pilot valve should be 1.5 to 21 MPa (220 to 3050 PSI) and should also be 60 % of actual supply pressure or more.

(4) The pilot flow is calculated based on 14 MPa (2030 PSI) of pilot pressure and the above step response.

(5) To use the external pilot types with supply pressure of 21 MPa (3050 PSI) or more, pressure at the port T/Y should be 7 MPa (1020 PSI) or less.

(6) This value is measured for each valve based on 14 MPa (2030 PSI) of pilot pressure; it may differ depending on the actual circuit/operation conditions.

(7) There are restrictions on the mounting position; refer to the instructions for use.